

Three phase power solid state relay
Relais statique triphasé de puissance

SGT9654302

Output / Sortie : 24-600VAC (±10%)
Input / Entrée : 4-30VDC

50A / 1200Vpeak Thyristors.
I²t=1680 A²s
27A AC51 (Resistive / Résistif).

- Zero Cross Solid State Relay specially designed for resistive loads.
- Over-Voltage protection (TVS) on input and output.
- Back to back thyristors on output with TMS² technology for a long lifetime expectancy, RoHS void free process.
- Direct copper bonding (DCB) technology.
- Large control range: 4-30VDC with input current limiter. Green LED visualization on the input.
- Designed in conformity with IEC/ EN60947-4-3
- Built in IP20 - protection with flaps
- Relais statique synchrone spécialement adapté aux charges résistives.
- Protection en tension (TVS) sur l'entrée et sur la sortie.
- Sorties thyristors technologie TMS² permettant une longue durée de vie, procédé soudure RoHS sans voids.
- Technologie DCB (Direct Copper Bonding).
- Large plage de contrôle: 4-30VDC avec un courant de commande régulé. LED de visualisation sur l'entrée de couleur verte.
- Construit en conformité à la norme IEC/EN60947-4-3.
- Protection contre le toucher IP20 avec volets de protection.



Typical application / Application typique:

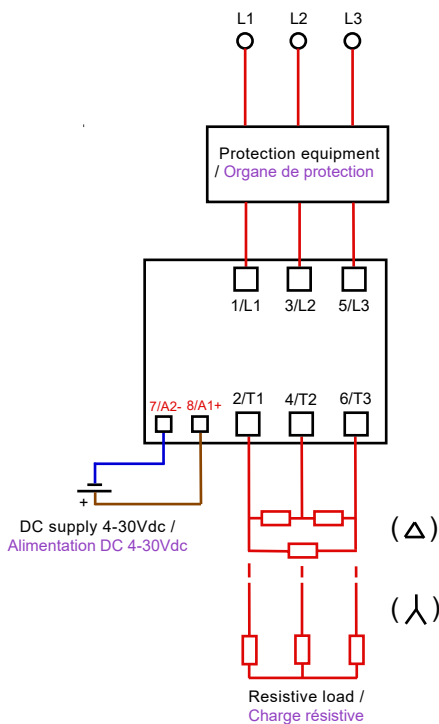

Synoptic / Synoptique:

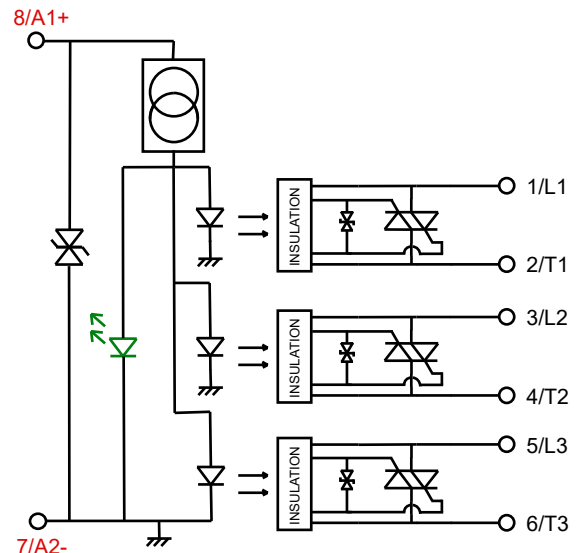

Proud to serve you

Control characteristics (at 25°C) / Caractéristiques de commande (à 25°C)

Parameter / Paramètre	Symbol	DC			Unit
		Min	Nom	Max	
Control voltage / Tension de commande	Uc	4		30	V
Control current (@Uc) / Courant de commande	Ic			<25	mA
Release voltage / Tension de relachement	Uc off	2			V
Input internal resistor / Résistance interne	Rc	Current regulator			Ω
Reverse voltage / Tension inverse	-Uc		30		V

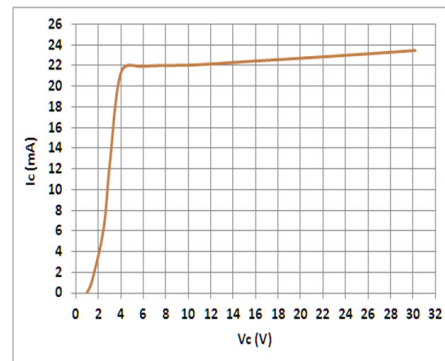

Output characteristics (at 25°C) / Caractéristiques de sortie (25°C)

Parameter per leg / Paramètre par voie	Conditions	Symbol	Min	Typ.	Max	Unit
Operating voltage range / Plage de tension d'utilisation	(+/- 10%)	Ue	24		600	V rms
Peak voltage (self turn ON) / Tension crête (auto-amorçage)		Up	1200 (1100)			V
Zero cross level / Niveau de synchronisme		Usync		30		V
Latching voltage / Tension minimum amorçage	Ie typ	Ua			10	V
Nominal current / Courant nominal	@40°C (AC-51) ⁽¹⁾	Ie AC-51		27		A rms
Non repetitive overload current / Courant de surcharge	tp=10ms	Iism	530	580		A
On state voltage drop / Chute directe à l'état passant	@ 25°C	Vt			0.85	V
On state dynamic resistance / Résistance dynamique		rt		7,5		mΩ
Output power dissipation (max value) / Puissance dissipée (max)		Pd	(0,9x0.85xIe + 0,0075 x Ie ²)x3			W
Thermal resistance between junction to case (one leg) / Résistance thermique jonction/semelle (1 voie)		Rthj/c		0.55		K/W
Off state leakage current / Courant de fuite à l'état bloqué	@Ue typ, 50Hz	Iik			1	mA
Minimum load current / Courant minimum de charge		Iemin	5			mA
Turn on time / Temps de fermeture (cycles)		ton max		0,5		
Turn off time / Temps d'ouverture (cycles)		toff max		0,5		
Operating frequency range / Fréquence utilisation	F mains	f	0,1	50-60	400	Hz
Off state dv/dt / dv/dt à l'état bloqué		dv/dt	500			V/μs
Maximum di/dt non repetitive / di/dt max non répétitif		di/dt			50	A/μs
I ² t (<10ms)		I ² t	1404	1680		A ² s
Conducted immunity level / Immunité conduite	IEC/EN61000-4-4 (bursts)		2kV criterion B			
Conducted immunity level / Immunité conduite	IEC/EN61000-4-5 (surge)		2kV criterion B			
Short circuit protection / Protection court-circuit	type 2 coordination	Example	Fuse MERSEN type gRC 50A			

⁽¹⁾ : with heatsink see fig 1. / Avec dissipateur voir fig1.



General characteristics (at 25°C) / Caractéristiques générales	Symbol	Min	Typ.	Max	
Input to output insulation / Isolement entrée/sortie	Ui		4000		VRMS
Output to case insulation / Isolation sortie/semelle	Ui		4000		VRMS
Insulation resistance / Résistance Isolement	Ri		1000 (@500VDC)		MΩ
Rated impulse voltage / Tenue aux tensions de chocs	Uimp		4000		V
Protection level / Degré de protection / CEI529			IP20		
Pollution degree / Degré de pollution	-		2		
Vibration withstand / Vibrations IEC60068-2-6 ⁽²⁾			1,5		mm
Shocks withstand / Tenue aux chocs IEC60068-2-6	-		30/50		g
Ambient temperature / Température de fonctionnement	-		-40 /+100		°C
Storage temperature / Température de stockage ⁽³⁾			-40/+125		°C
Ambient humidity / Humidité relative	HR		40 to 85		%
Weight / Poids			740		g
Conformity / Conformité			EN60947-4-3 (IEC947-4-3)		
			EN 62314		
Conformity (VDE laboratory) / Conformité	EN				
Conformity / Conformité	UL/CSA		cURus		
Housing Material / Matière du boîtier			PA 6 UL94VO		
Housing Material / Matière du boîtier			EN 60695-2 (VDE approval)		
Base plate / Semelle			Tin plated Aluminum / Aluminium étamé		

⁽²⁾ : 10-150Hz, double amplitude / 10-150Hz double amplitude

⁽³⁾ : no icing, no condensation / pas de glace, pas de condensation

Thermal curves / Courbes thermiques (fig 1.)

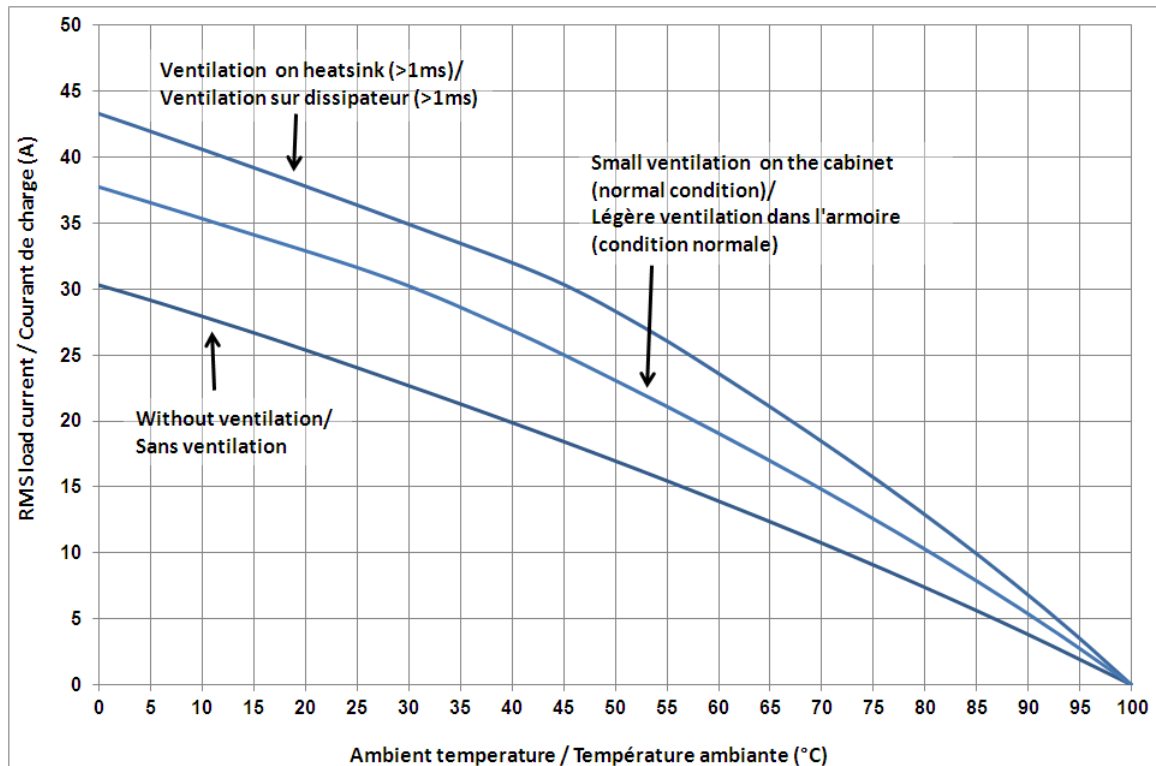

Overload currents / Courants de surcharges:

1 - No repetitive I_{tsm} (1) is given without voltage reapplied .
This curve is used to define the protection (fuses).

1 - I_{tsm} non répétitif (1) sans tension réappliquée est donné pour la détermination des protections (fusibles).

2 - Repetitive I_{tsm} (2) is given for inrush current with initial $T_j = 70^\circ\text{C}$. In normal operation, this curve musn't be exceeded.
Caution, frequent over load currents will decrease the life expectancy of the SSR.

2 - I_{tsm} répétitif (2) est donné pour des surcharges de courant (T_j initiale= 70°C).

Attention : la répétition (en usage normal) de surcharges de courant diminue la durée de vie du relais.

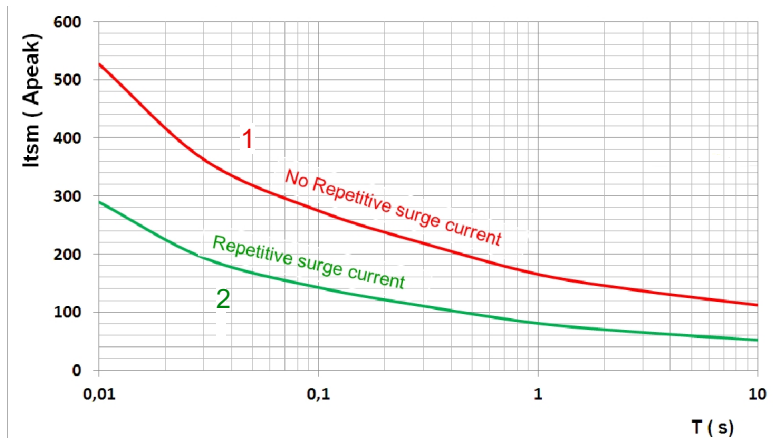

→ Warning ! semiconductor relays don't provide any galvanic insulation between the load and the mains. Always use in conjunction with an adapted circuit breaker with insulation feature or a similar device in order to ensure a reliable insulation in the event of wrong function and when the relay must be insulated from the mains (maintenance ; if not used for a long duration ...).

It is important that the solid state relay is subject to correct installation, maintenance and use conforming to its intended regulations and standards, to the supplier's instructions and to accepted rules of art.

→ Attention ! les relais à semi-conducteurs ne procurent pas d'isolation galvanique entre le réseau et la charge. Ils doivent être utilisés associés à un disjoncteur avec propriété de sectionnement ou similaire, afin d'assurer un sectionnement fiable en amont de la ligne dans l'hypothèse d'une défaillance et pour tous les cas où le relais doit être isolé du réseau (maintenance; non utilisation sur une longue durée...).

Il est important que le relais statique soit soumis à une installation, une maintenance et une utilisation correcte, conformes aux réglementations et normes prévues, aux instructions du fournisseur et aux règles de l'art.

Connections / Raccordement:



Direct connection with wires with or without ferrules /
Directement avec fils avec ou sans embouts

With ring terminals /
Avec cosses

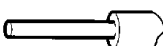
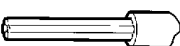
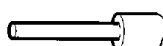
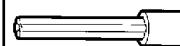

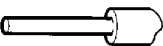
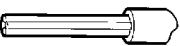
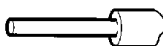
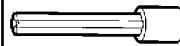
cel3pac® <u>Control wiring / Raccordement d'entrée</u>					
Number of wires / Nombre de fils				Screwdriver type / Modèle de tournevis	Couple de serrage recommandé Vis M4
1		2			
SOLID (No ferrule) Fil rigide (sans embout)	FINE STRANDED (With ferrule) Fil multibrins (avec embout)	SOLID (No ferrule) Fil rigide (sans embout)	FINE STRANDED (With ferrule) Fil multibrins (avec embout)		Recommended tightening torque M4 screw N.m
					
AWG18....AWG14 0,75 ... 2,5 mm ²	AWG18....AWG14 0,75 ... 2,5 mm ²	AWG18....AWG14 0,75 ... 2,5 mm ²	AWG18....AWG14 0,75 ... 2,5 mm ²	POZIDRIV 2	Mini 1,2 / Typ 1.5 / Max 2

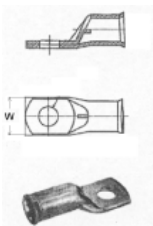
cel3pac® <u>Power wiring / Raccordement de puissance</u>					
Number of wires / Nombre de fils				Screwdriver type / Modèle de tournevis	Couple de serrage recommandé Vis M5
1		2			
SOLID (No ferrule) Fil rigide (sans embout)	FINE STRANDED (With ferrule) Fil multibrins (avec embout)	SOLID (No ferrule) Fil rigide (sans embout)	FINE STRANDED (With ferrule) Fil multibrins (avec embout)		Recommended tightening torque M5 screw N.m
					
AWG16....AWG8 1,5 ... 10 mm ²	AWG16....AWG10 1,5 ... 6 mm ²	AWG16....AWG8 1,5 ... 10 mm ²	AWG16....AWG10 1,5 ... 6 mm ²	POZIDRIV 2	Mini 2 / Typ 2.4 / Max 3

<p>Power with ring terminal /Puissance avec cosses</p> <p><u>W max =12,6mm</u> 16 mm² (AWG6) 25 mm² (AWG4) 35mm² (AWG2 /AWG3) 50mm² (AWG0 /AWG1)</p> 	<p>IP20 flaps / Volets IP20 Flaps are delivered mounted on the relay. Les volets sont montés en standard en usine</p> <p><u>Labels / Etiquettes</u> Marking labels are available, for mounting on flaps. Part number : 1MZ09000 (delivered per 200 parts) Des étiquettes de repérage sont aussi disponibles. Quantités par 200 pièces Montage sur volets (1MZ09000).</p> 
--	--

Dimensions / Dimensions:

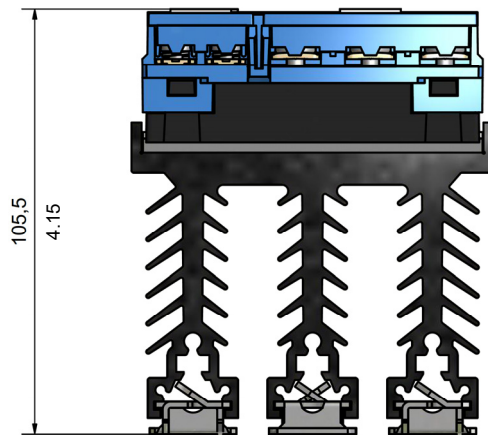

mm
(inches)

