

**PRINCIPAL TECHNICAL CHARACTERISTICS**  
**CARACTERISTIQUES TECHNIQUES PRINCIPALES**

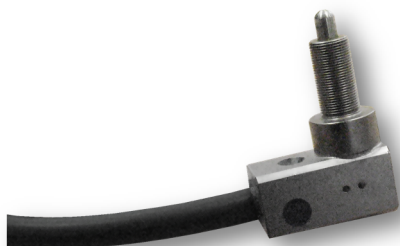

- **Waterproof limit switch (snap action)**  
*Fin de course étanche à rupture brusque*
- **Rounded end or roller ended actuator**  
*Poussoir à tête sphérique ou à galet.*
- **Operating point adjustment by the mounting nuts and positioning washers on the mounting panel.**  
*Ajustement du point de fonctionnement par positionnement des écrous de fixation sur le corps fileté.*
- **Weight : 130g ± 5% (Without cable)**  
*Masse: 130g ± 5% (sans câble)*
- **All stainless steel material**  
*Entièrement en matériaux inoxydables*
- **Special models available upon request**  
*Modèles spécifiques sur demande*

**CONTACT ELECTRICAL CHARACTERISTICS**  
**CARACTERISTIQUES ELECTRIQUES DES CONTACTS**

Load type <i>Type de charge</i>	30Vdc	
	Nominal rating <i>Courant nominal</i>	Overload rating <i>Courant de surcharge</i>
Resistive load   <i>Charge résistive</i>	1A	2A
Inductive load   <i>Charge inductive (L/R=5ms)</i>	0.7A	1.5A
Low level   <i>Bas niveau</i>	50mA max / 0.5mA min	-

**GENERAL CHARACTERISTICS**  
**CARACTERISTIQUES GENERALES**

Operating temperature <i>Température d'utilisation</i>	-10°C to +55°C
Humidity   <i>Humidité</i>	40% to 100%
Vibration   <i>Vibration</i>	1g 16 to 55 Hz
Shock   <i>Chocs</i>	50g 11 ms
Water, dust and sand, protection level <i>Niveau de Protection contre l'eau et les poussières</i>	IP 66 according to IEC 529
Voltage drop, without cable ( refer to "electrical connection" for cable voltage drop detail) <i>Chute de tension, sans câble (voir « connexion électrique » pour le détail de la tension du câble</i>	≤30mV at 1A
Electrical life at nominal voltage   <i>Durée de vie électrique sur charge nominale</i>	50 000 cycles

**AMERICAS.**

Tel: +1 714-736-7599  
<http://www.esterline.com/powersystems>

**EUROPE.**

Tel: +33 3 87 97 31 01  
Fax: +33 3 87 97 96 86

**ASIA**

Tel: +852 2 191 3830  
Fax: +852 2 389 5803

### BODY STYLE [1] TYPE DE CORPS [1]

Body style C: L shape  
Type de corps C : coudé

Body style D: straight  
Type de corps D : droit

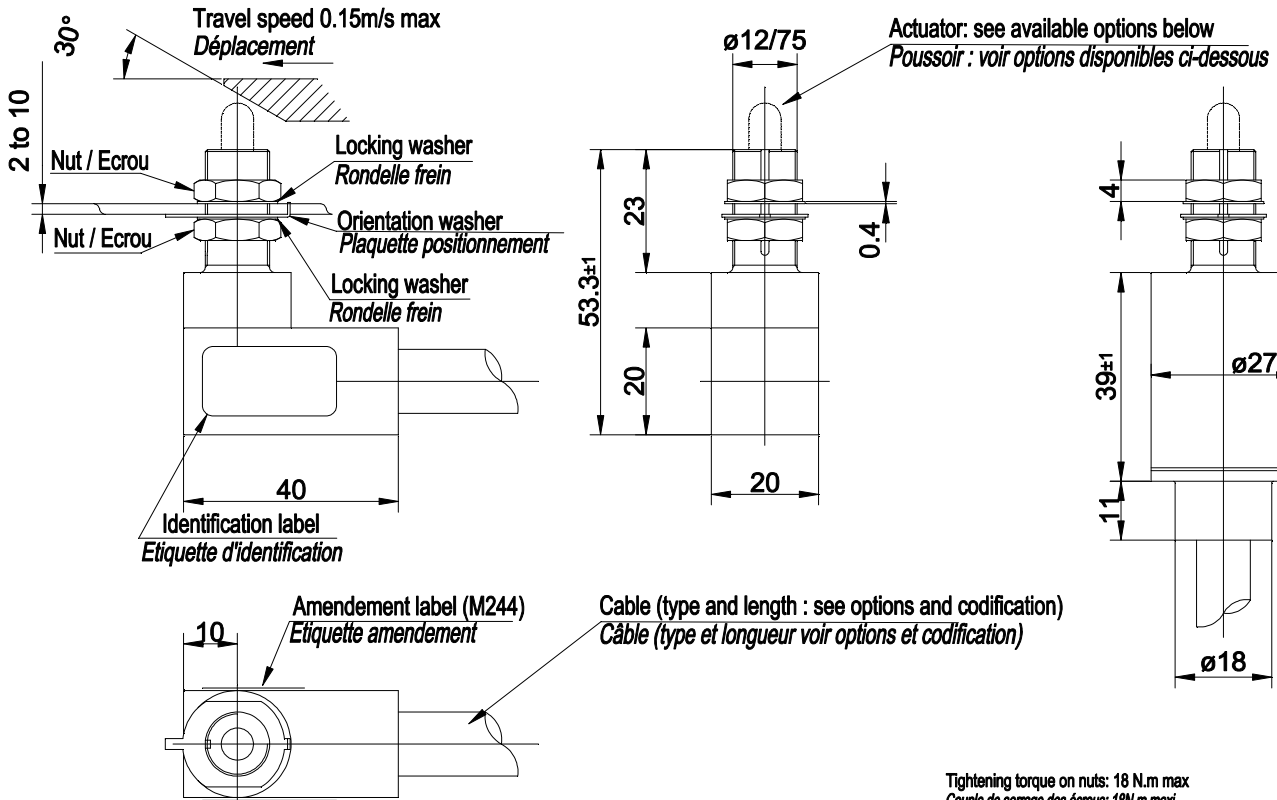

### ACTUATOR STYLE [1] STYLE DE POUSSOIRS [1]

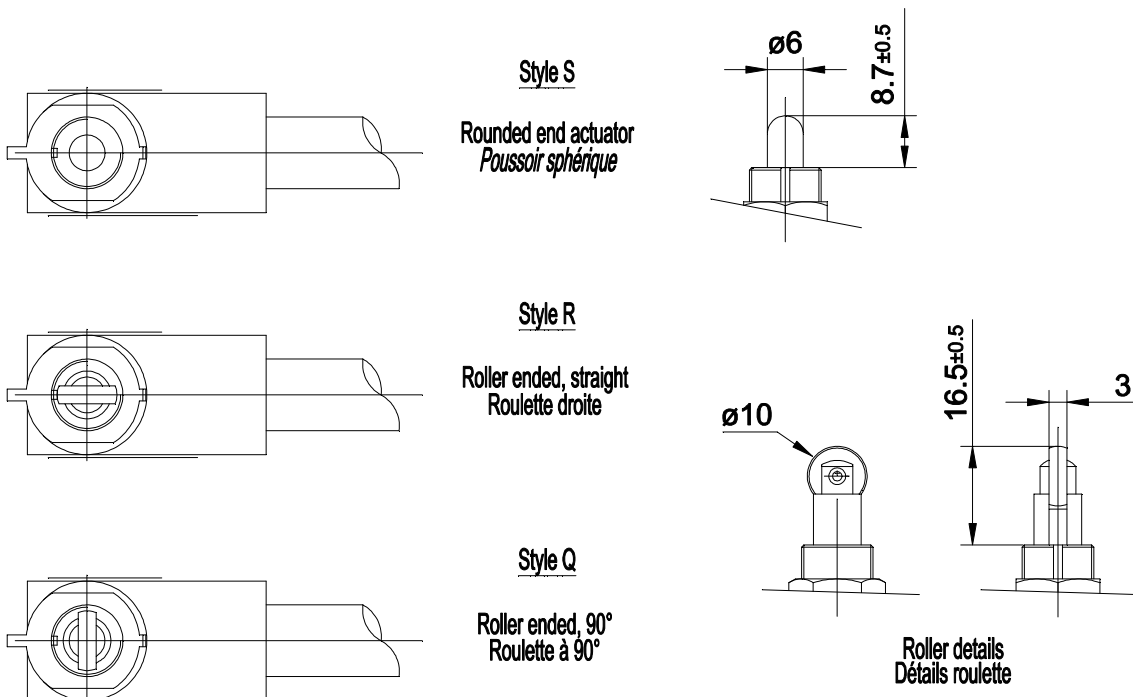

### FIXING DETAILS [1] DETAILS FIXATION [1]

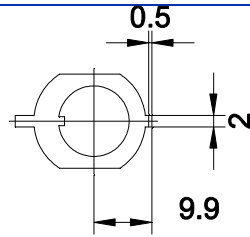

Detail of orientation washer  
Detail de la rondelle de positionnement  
Thickness / Epaisseur : 0.5 mm±0.1

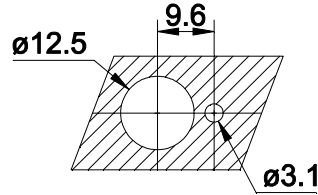

Panel cutout  
Decoupe support

### MECHANICAL CHARACTERISTICS [1] CARACTERISTIQUES MECANIQUE [1]

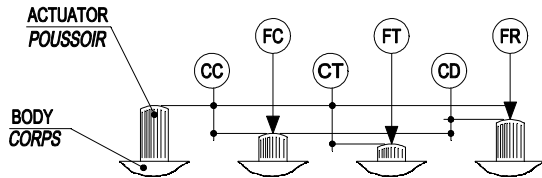

#### TRAVEL / COURSES

CC= OPERATING TRAVEL / COURSE DE COMMANDE  
CT= TRAVEL TOTAL MAX / COURSE TOTAL MAXI  
CD= DIFFERENTIAL TRAVEL / COURSE DIFFÉRENTIELLE

POSITION	REPOS	TRAVAIL	FIN DE COURSE	RELACHEMENT
CIRCUIT ELECTRIQUE CORRESPONDANT				

#### FORCES / EFFORTS

FC= OPERATING FORCE / FORCE DE COMMANDE  
FT= TOTAL TRAVEL FORCE / FORCE DE COURSE TOTALE  
FR= RELEASE FORCE / FORCE DE RELÂCHEMENT

TRAVEL / COURSES (mm)		
CC	OPERATING	≤ 1.2
CT	TOTAL	≥ 5
CD	DIFFERENTIAL	≤ 0.4
SIMULTANEITY OF BOTH CONTACTS SIMULTANEITE DES DEUX CONTACTS		≤ 0.25

FORCES / EFFORTS		
FC	OPERATING	≤ 3
FT	TOTAL MAX	≤ 15
FR	DIFFERENTIAL	≥ 1

### ELECTRICAL CONNECTION [1] CONNEXION ELECTRIQUE [1]

Cable code	Cable type	Note
M	NNO 6145.14.433.8816	Voltage drop at 1A : 70mV/m Approx weight: 134g/m
S	NNO 6145.14.456.3588 (shielded)	Voltage drop at 1A : 70mV/m Approx weight: 280g/m

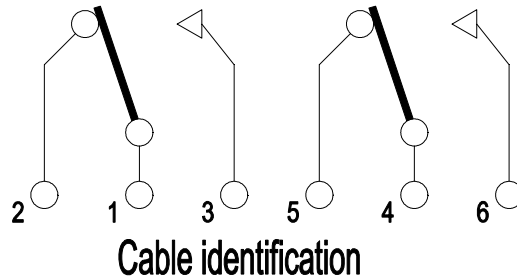

### NUMBERING SYSTEM [1] SYSTEME DE REFERENCES [1]

Basic series designation | Référence de base

1. **Body style** | Type de corps (D, C)
2. **Actuator style** | Type de poussoir (R, S, Q)
3. **Cable type** | Type de sortie (M, S)
4. **Cable length** | Longueur de câble (in dm)
5. **Low level option**  
Option bas niveau (1= low level, Omitted=standard)

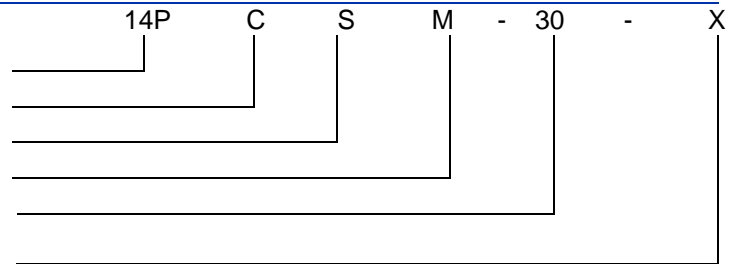

Exemple : 14PCSM-30-1 : L shape body, rounded end actuator, cable type M, 3 meters long, low level

Corps type L, actionneur arrondie, câble type M, 3 mètres de long, bas niveau

### NOTES REMARQUES

- [1]. Other configurations may be possible. Please contact factory  
D'autres configurations peuvent être possibles : Nous consulter.